

V-01
ESC: 1/25

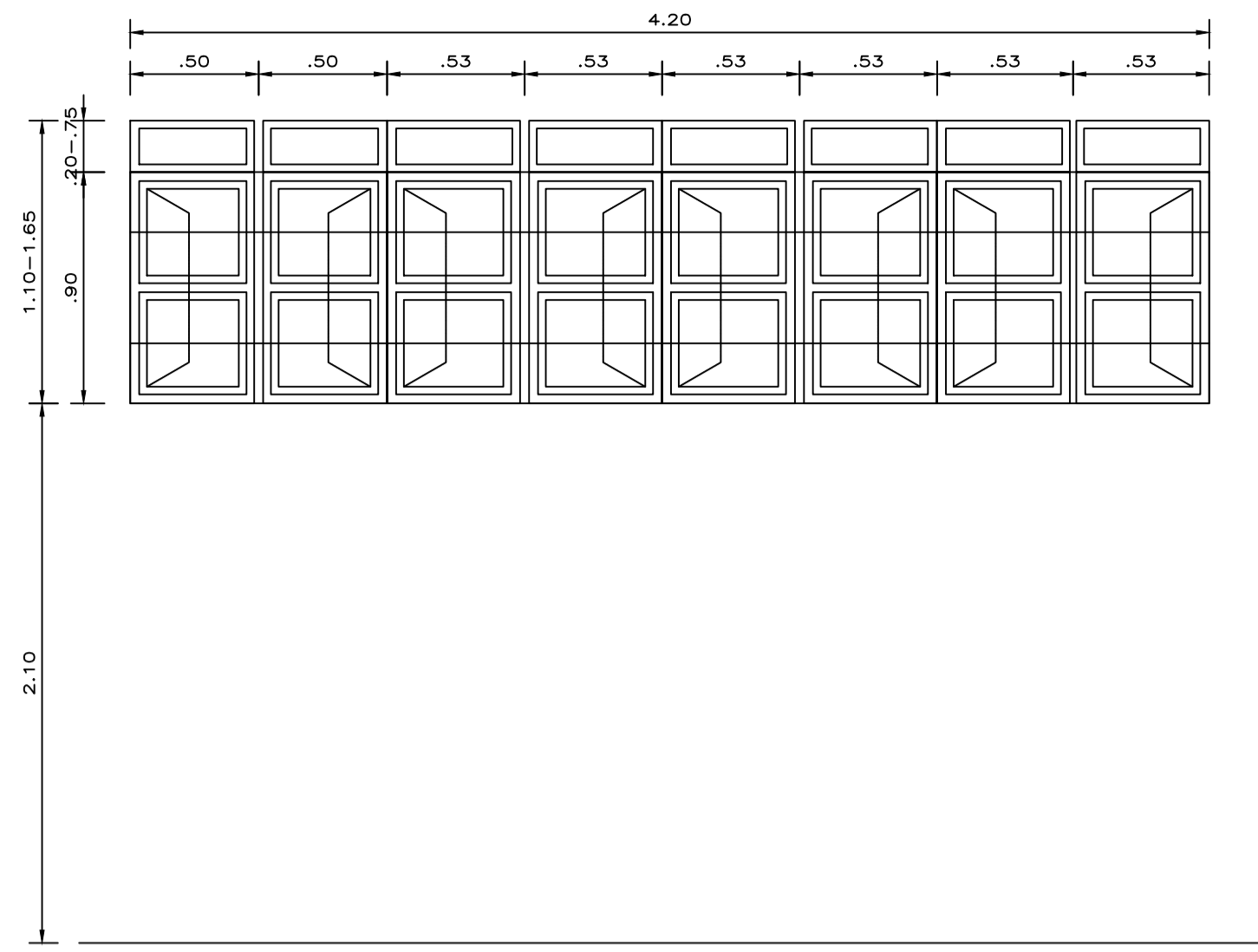

V-02, V-02'
ESC: 1/25

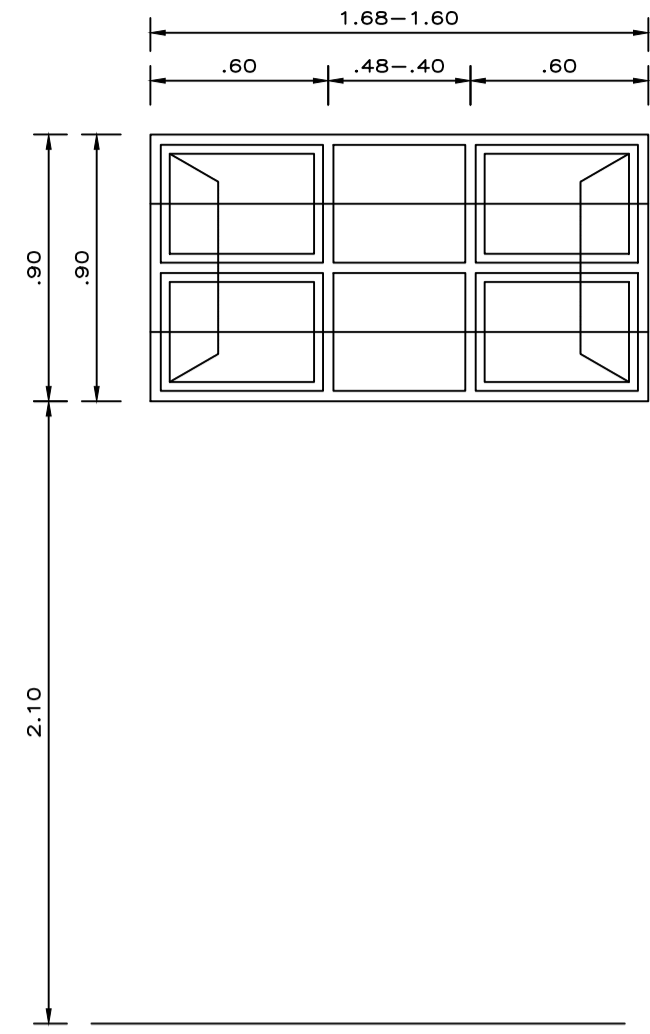

V-03, V-18
ESC: 1/25

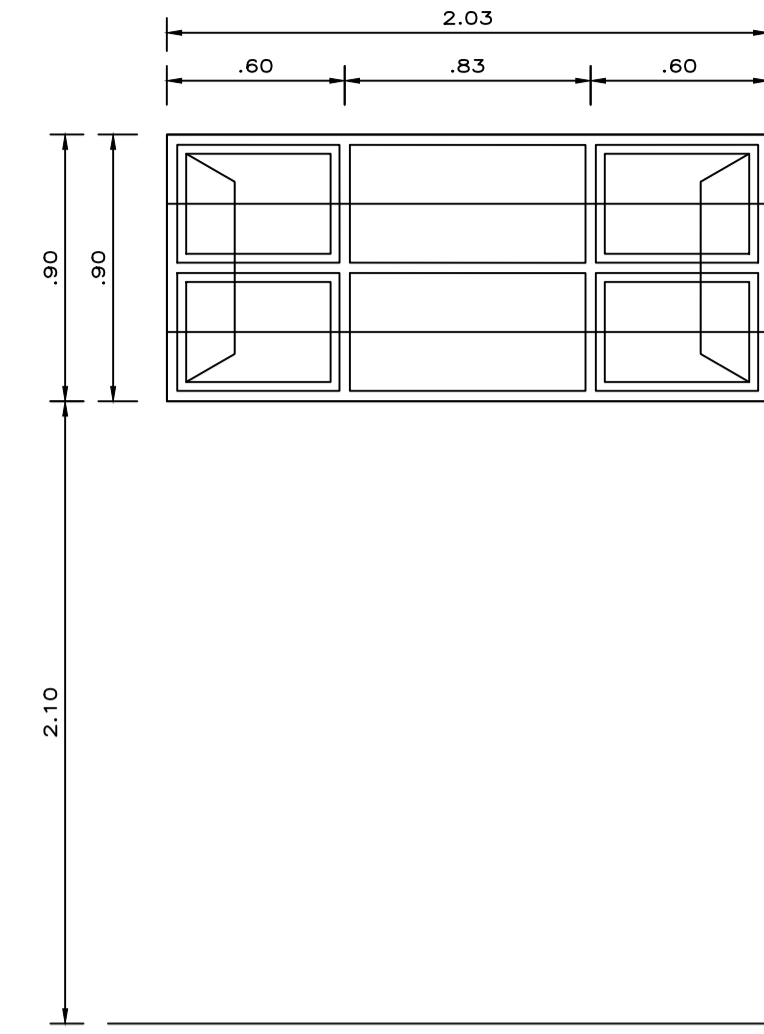

V-04
ESC: 1/25

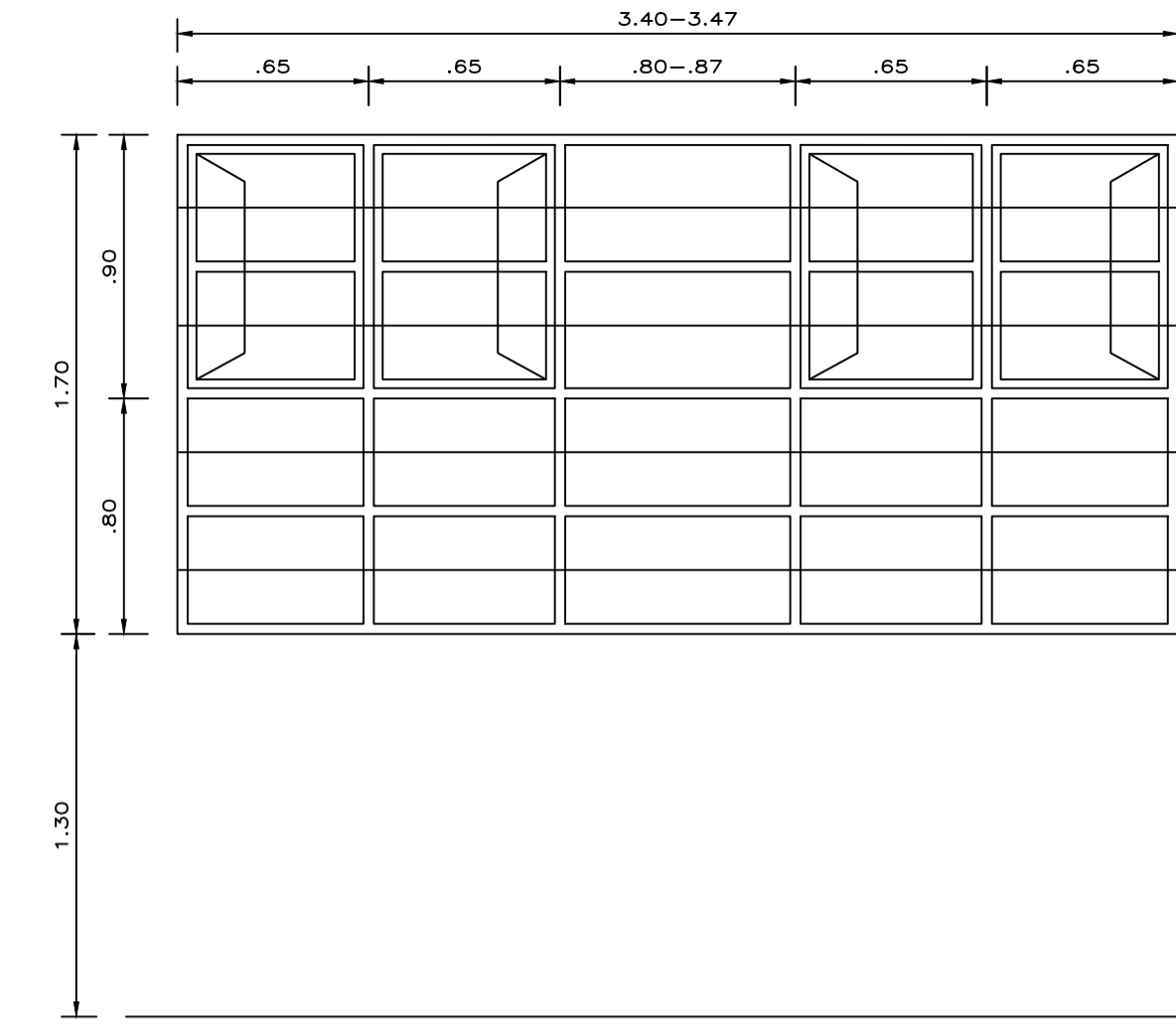

V-05, V-09
ESC: 1/25

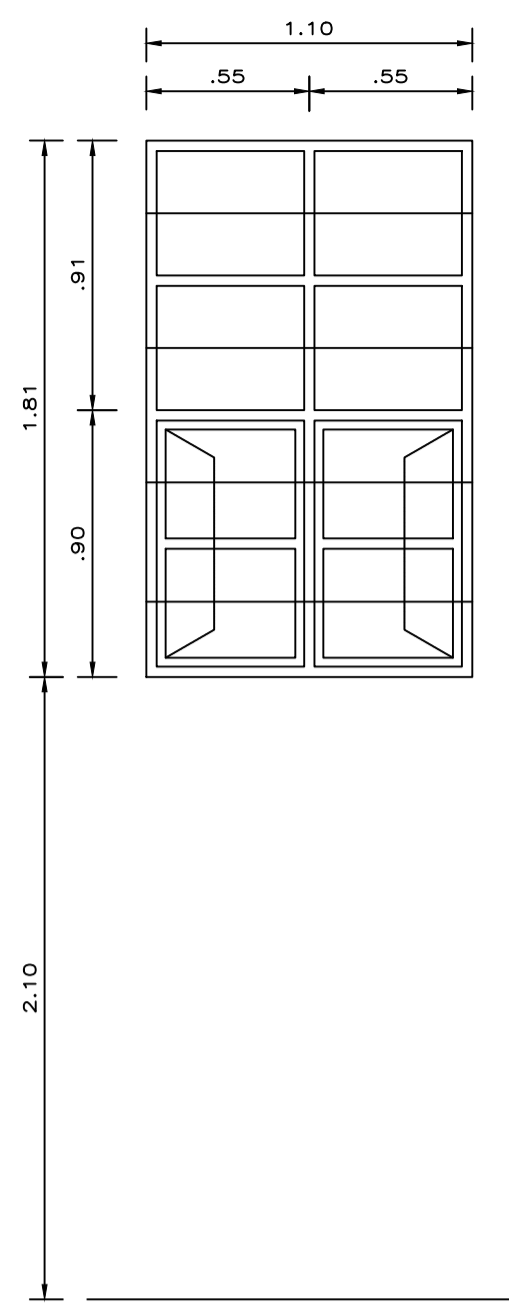

V-A, V-A'
ESC: 1/25

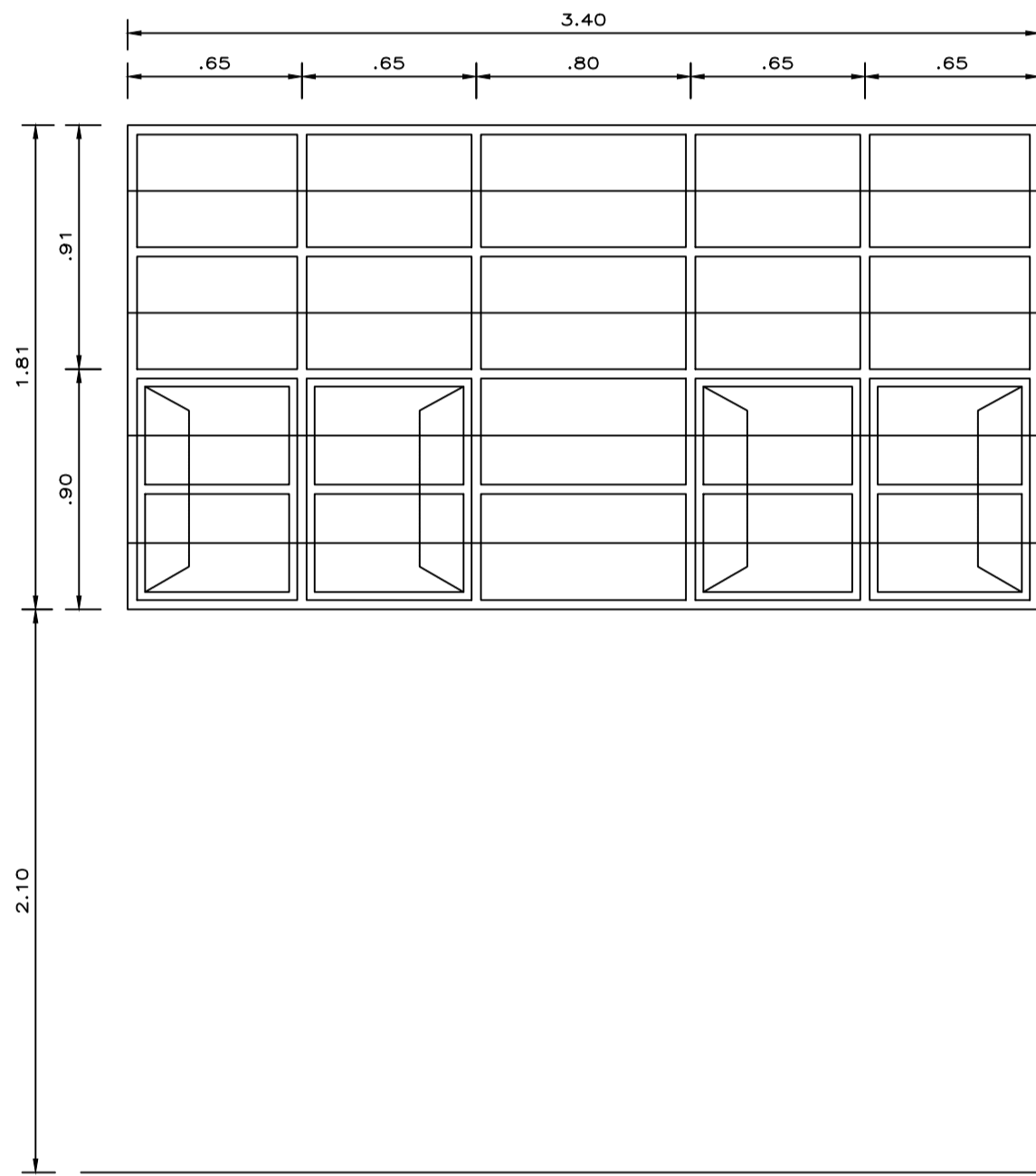

V-05', V-19
ESC: 1/25

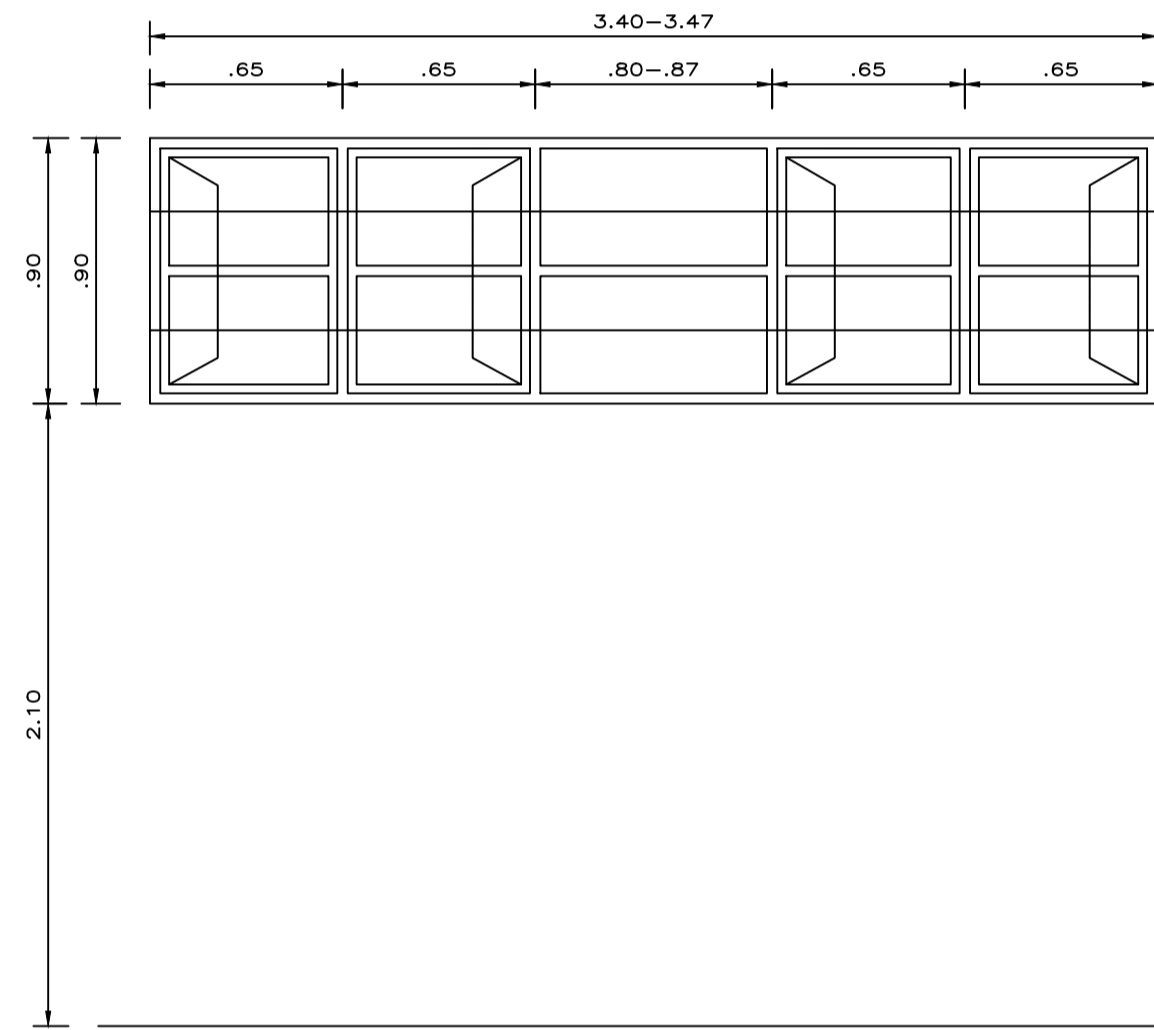

V-06, V-08, V-20
ESC: 1/25

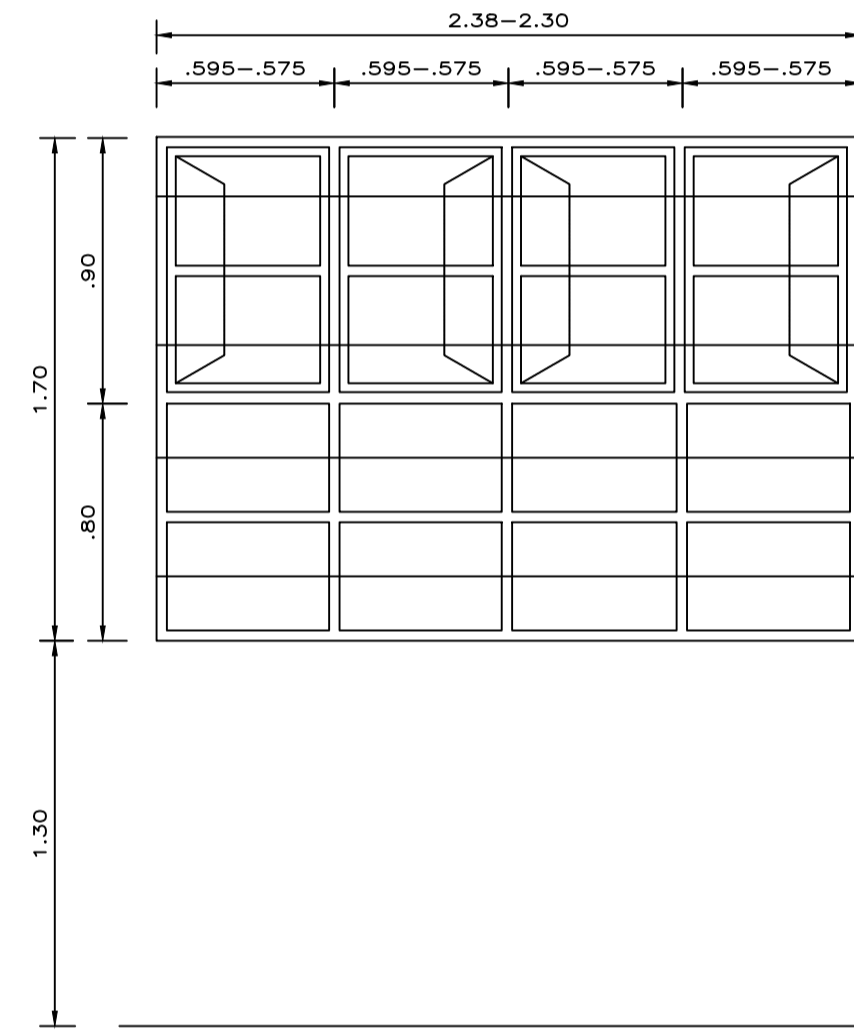

V-07, V-10
ESC: 1/25

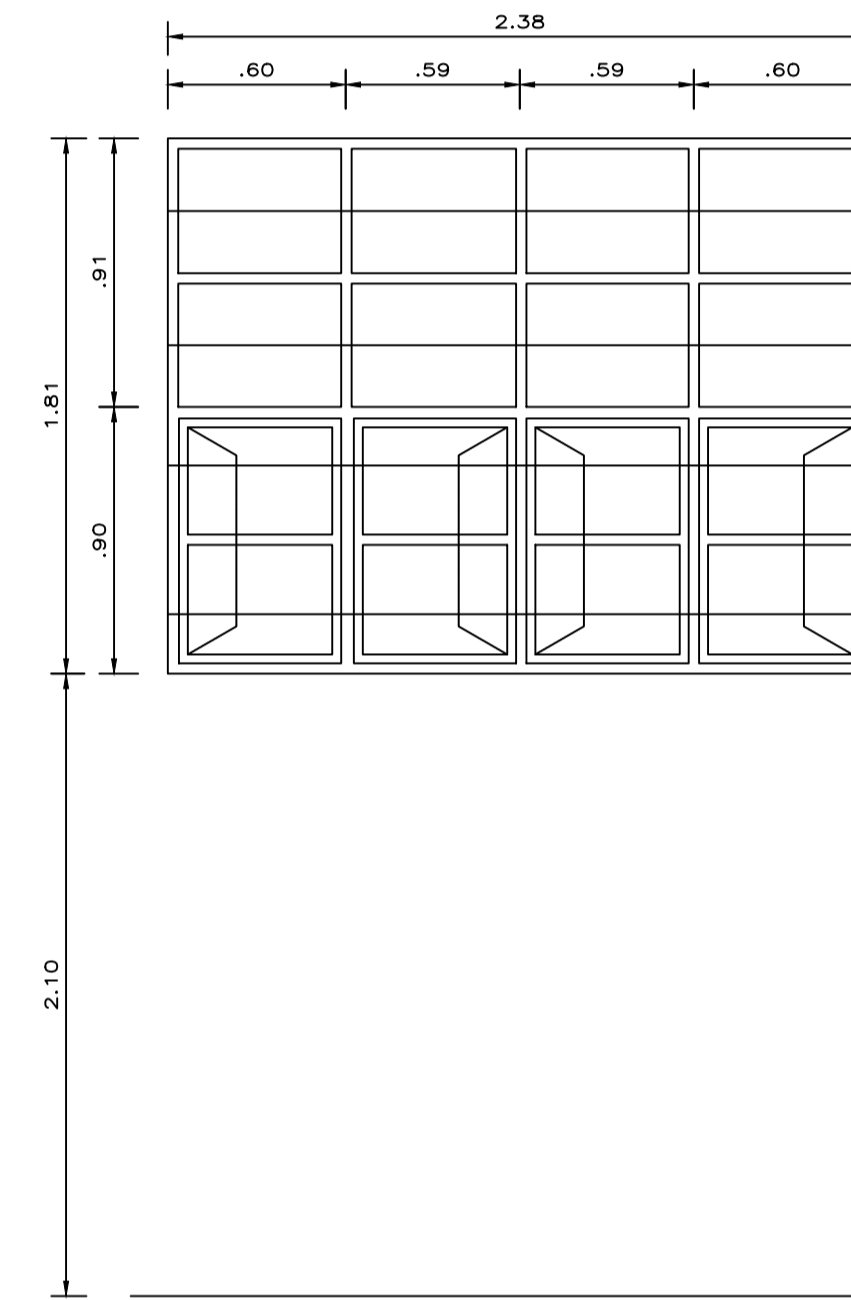

V-07'
ESC: 1/25

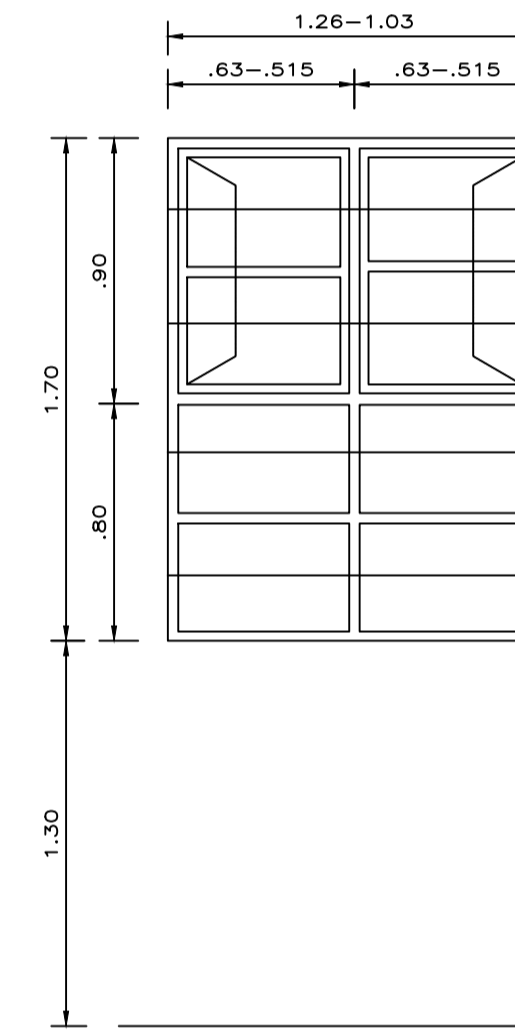

V-11, V-13
ESC: 1/25

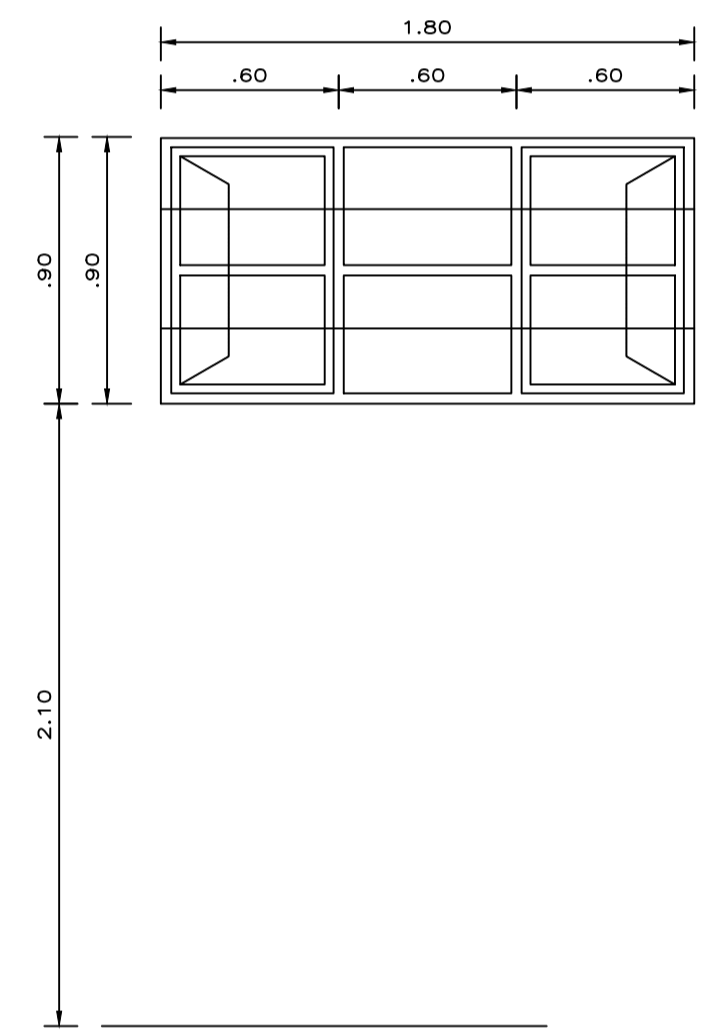

V-B
ESC: 1/25

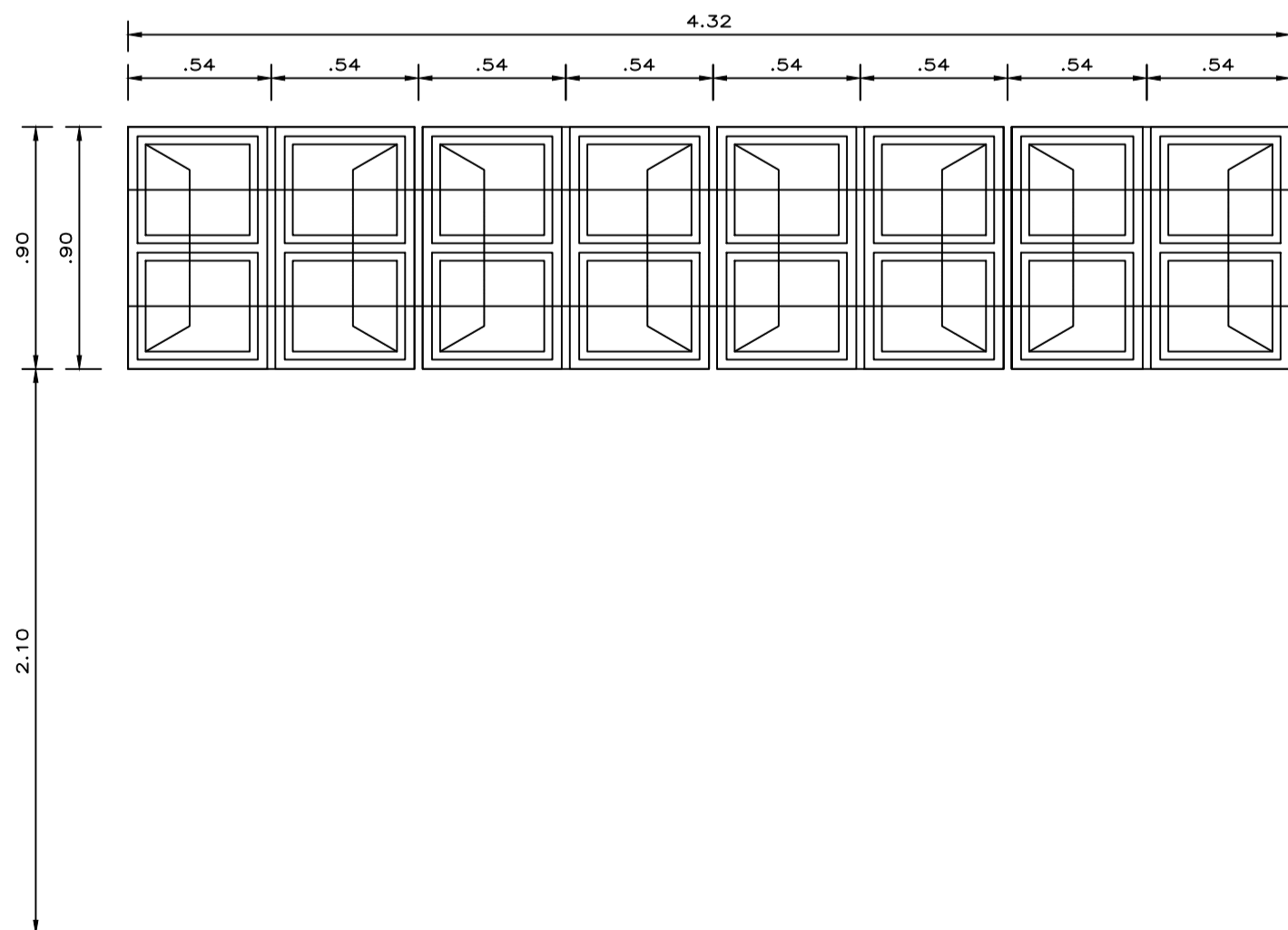

V-12
ESC: 1/25

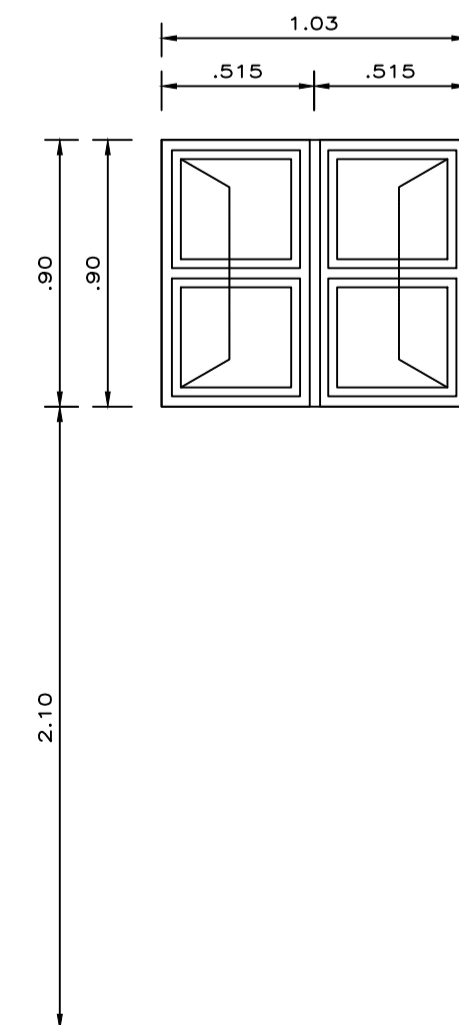

V-14
ESC: 1/25

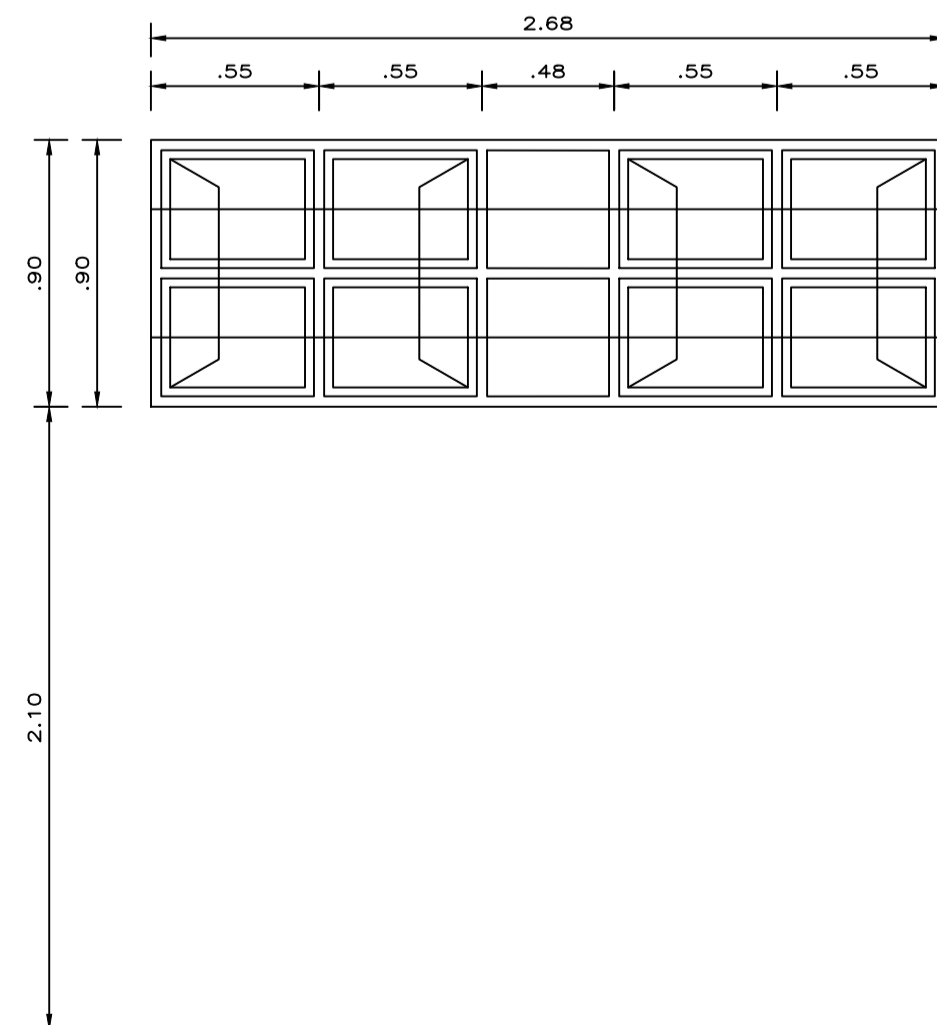

V-15
ESC: 1/25

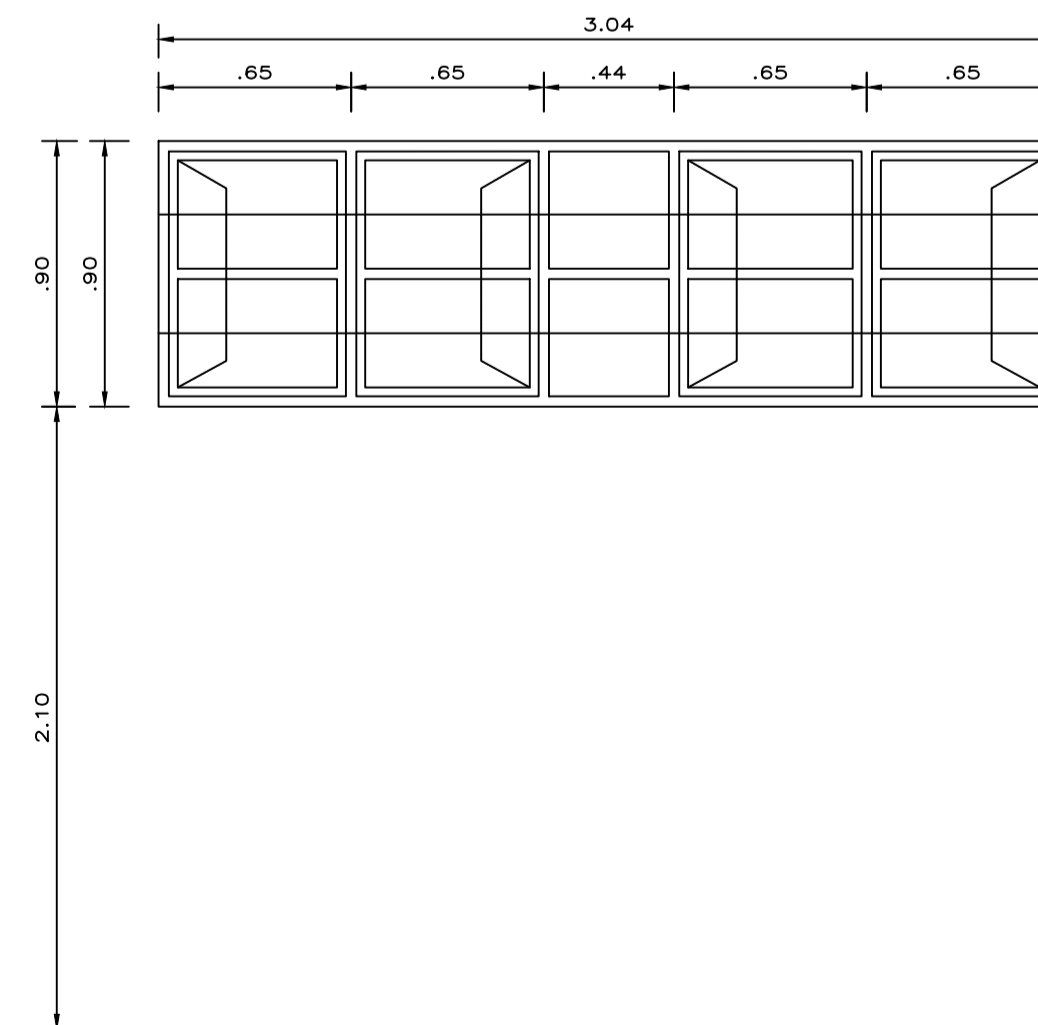

V-16
ESC: 1/25

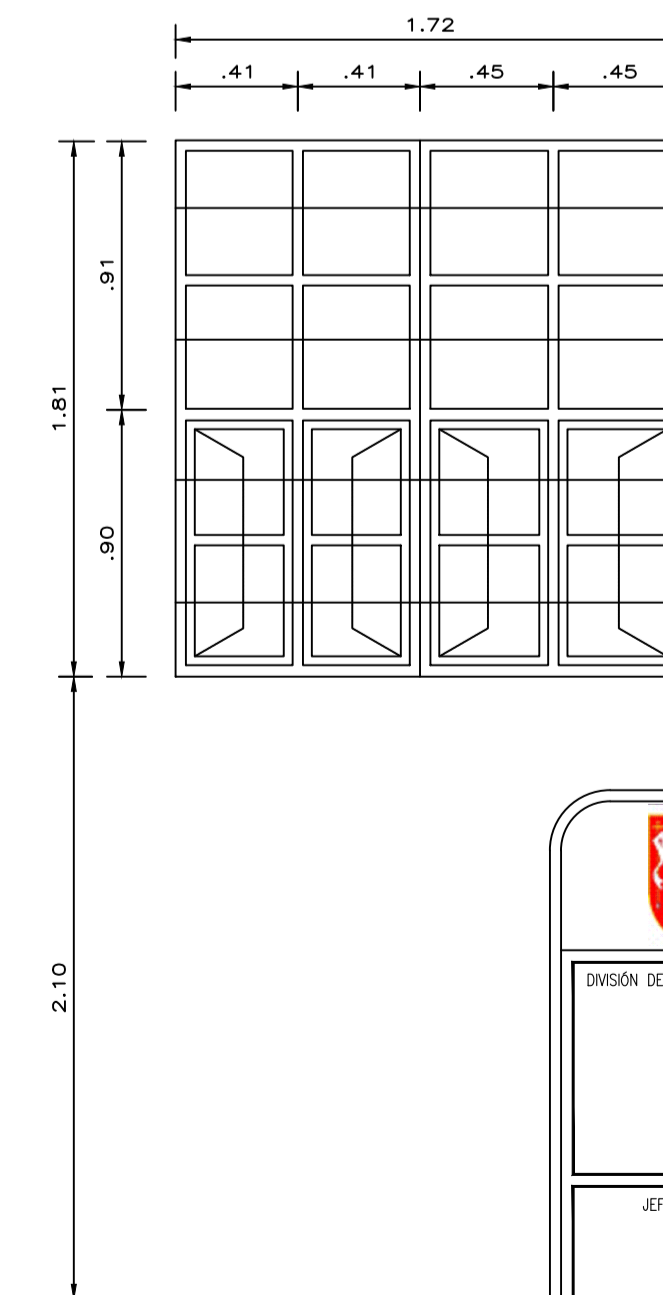

V-17
ESC: 1/25

 MUNICIPALIDAD PROVINCIAL DE PIURA GERENCIA DE TERRITORIAL Y TRANSPORTE DIVISION DE ESTUDIOS Y PROYECTOS	
DIVISION DE ESTUDIOS Y PROYECTOS	PROYECTO: RECUPERACION DEL LOCAL ESCOLAR 412 CON CODIGO LOCAL 413227 DISTRITO DE CATACAOS - PIURA - PIURA
JEFE DE PROYECTO	PLANO: VENTANAS DE MADERA ESPECIALIDAD: ARQUITECTURA
UBICACION: DPTO: PIURA - PROVINCIA: PIURA - DISTRITO: CATACAOS	CODIGO PLANO: A-13
FECHA: NOVIEMBRE 2021	ESCALA: 1 / 25